

How to Fix a Flat

You can do it!



1. Meet our flat tire kit!

Levers

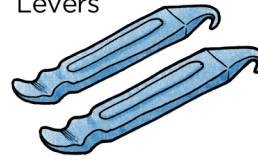

Patch Kit

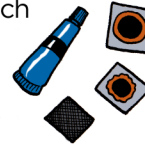

Pump

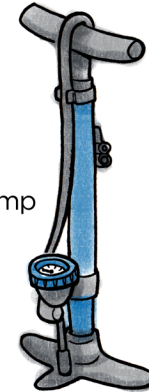

2. Remove your wheel.

Flip up the quick release handle and spin it counter-clockwise to loosen.

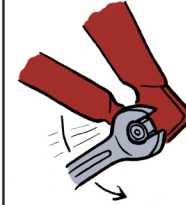

No quick release? Use a wrench to loosen the bolt (usually 15mm).

You may have to loosen your brakes to get the wheel off.

3. Let any air out of the tube.



If your valve looks like this, it's a **Schrader valve**. Push the little bit inside to let the air out.

If your valve looks like this, it's a **Presta valve**. Unscrew the top part, then press it down to let the air out.

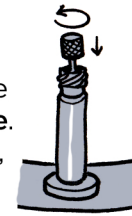

4. Bike wheel cross-section:

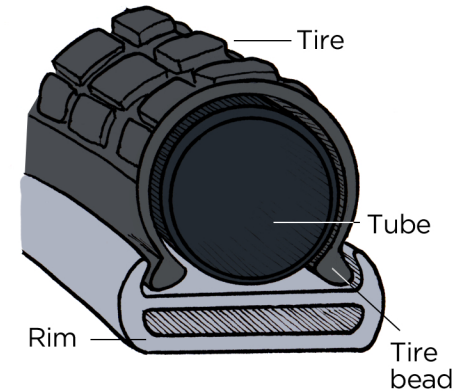

5. Stick the lever between the tire and the rim.

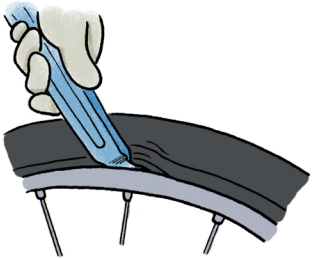

Hook the lever under the tire bead closest to you. Try not to pinch the tube with the levers.

6. Push lever handle down.

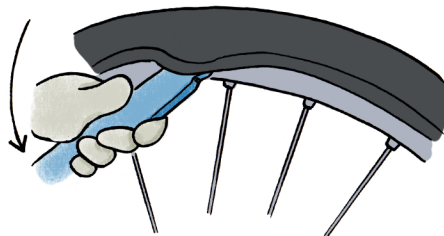

Your tire might be on there pretty tight! Use leverage between the lever and the rim.

7. Hook lever around spoke.

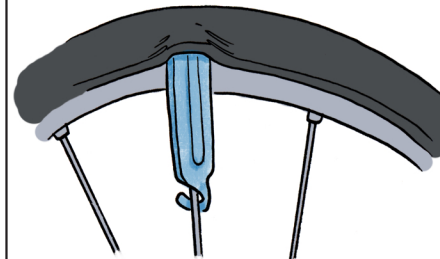

That will hold it in place while you insert a second lever and repeat steps 6 and 7.

8. Push the two levers apart.

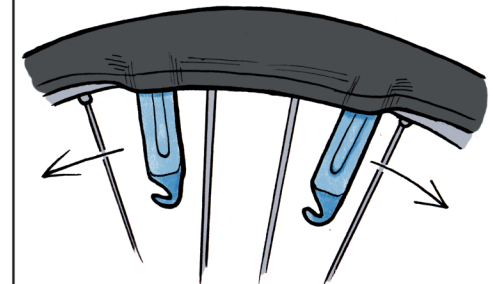

Work the levers around the rim until you've completely removed the tire from one side of the rim.

9. Pull the tube out from under the tire.

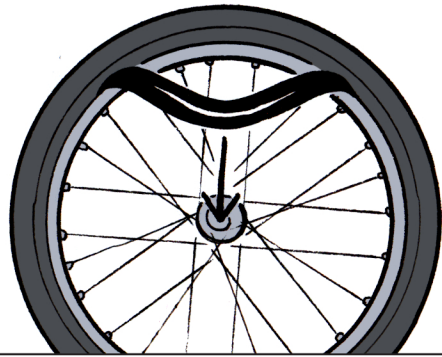

10. Pump up the tube like a balloon.

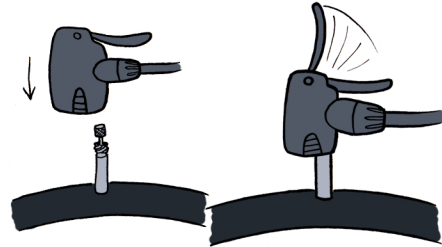

Press the nozzle onto the valve, then flip the lever up. If the pump has two holes, use the smaller for Presta, and the larger for Schrader.

11. Listen & feel for air coming from the puncture.

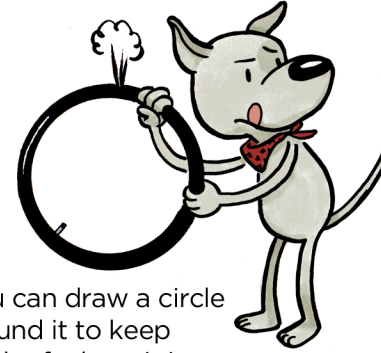

You can draw a circle around it to keep track of where it is.

12. Sand the area, apply glue.

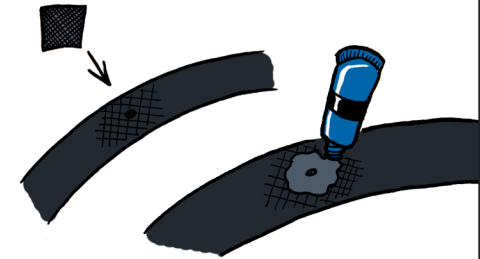

Sand the area around the puncture. Apply a **thin** layer of glue around the puncture (larger than the size of the patch) and let it dry completely.

13. Apply the patch.

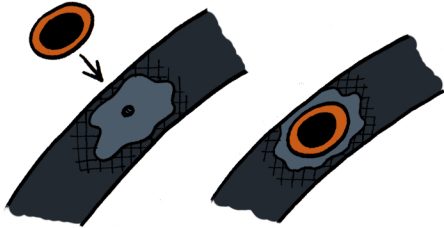

While you're waiting for the glue to dry, check your tire and rim for glass, nails, sharp points etc. Push the patch onto the tube, especially around the edges.

14. Push the valve through the hole in the rim.

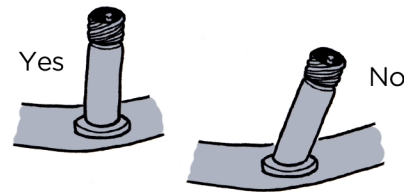

It helps to have *just* enough air in the tube so it will hold a circular shape, but no more than that. Place the valve at a 90° angle to the rim.

15. Push tube back under tire.



Try to seat the tube on the rim, the way it was before you took it out.

16. Roll tire back onto rim.

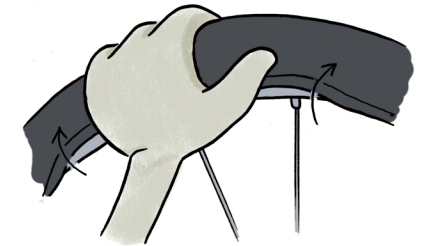

Use the heel of your hand to work the tire back on the rim, starting at the valve. If you use levers for this, careful not to puncture the tube!

17. Check that the tube isn't poking out of the tire.

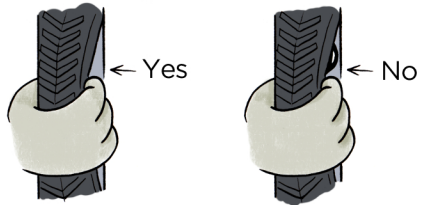

Before you fully inflate the tube, work all the way around the wheel, pushing the tire away from the edge of the rim, checking that the tube isn't poking out from the tire at all.

18. Inflate your tube.



Inflate your tube all the way. The side of your tire should say what the maximum pressure is, but if it doesn't 60 PSI is a safe bet.

19. Ride away triumphant!



You did it!
Great job!

About this Flyer

Brought to you by
Common Cycle



commoncycle.org

Created by
Sally Carson



fixpert.com

Creative Commons Attribution-ShareAlike license.
Feel free to share and remix this flyer, as long as you give credit to Common Cycle & Sally Carson. Thanks!